

SLG Liquid Flow Meter Series

Ultra-High Pressure Flow Meter for LC Applications

- Ultra-low Flow Sensing in the nl/min Range
- Operating Pressure up to 1200 bar (17500 psi)
- 40 ms Response Time



Product Summary

The SLG Liquid Flow Meter enables precise, bi-directional measurements of dynamic liquid flow rates in the nl/min to low μ l/min range. This device has been designed for ultra-high pressure applications in Liquid Chromatography Systems (UHPLC). Excellent bio-compatibility and chemical resistance is ensured by the use of fused silica, titanium and PEEK for all wetted parts.

Interface Options

Digital

- I²C-Bus
- RS485-Bus
- USB Cable

Analog

- Voltage Output (0-10 V)
- Additional operation modes

For more information on communication, please refer to page 2 of this document.

1 Sensing Performance

Table 1: Model specific performance of SLG (all data for medium H₂O, 23°C)

Parameter	SLG-0025	SLG-0075		SLG-0150	Unit
		Precision	Extended		
H ₂ O Full scale flow rate	1500	5000	20000	8000	nl/min
H ₂ O Sensor output limit ^a	1700	5500	2000/22000 ^b	10500	nl/min
Accuracy below full scale (whichever error is larger)	10	10	20	5	% of m.v. ^c
	0.5	0.5	n/a	0.5	% of full scale
Repeatability below full scale (whichever error is larger)	0.6	0.6	1.2	0.5	% of m.v.
	0.06	0.03	n/a	0.05	% of full scale
Temperature coefficient (additional error / °C; whichever is larger)	0.3	0.3	0.3	0.15	% m.v. / °C
	0.03	0.03	n/a	0.015	% full scale / °C
Mounting orientation sensitivity ^d	-	-	-	<0.4	% of full scale
Flow detection response time τ_{63}	40	40	120	40	ms
Response time on power-up	120				ms
Operating temperature	+10...+50				°C
Ambient storage temperature ^e	-10...+60				°C
Operating pressure	1200 (17500)			500 (7250)	Bar (psi)

^aFlow rate at which the sensor output saturates. See Section 2 for performance between full scale and saturation point

^bLower/upper limit

^cMeasured value

^dNo dependence on the mounting orientation for SLG-0025 and SLG-0075. SLG-0150: maximum additional offset when mounted vertically.

^eNon-condensing, flow path empty

1.1 Precision/Extended Mode with the SLG-0075

The SLG-0075 is offering two different flow sensing modes. The Precision Mode allows for precise flow sensing starting at zero flow while the Extended Mode is made for a rough estimation of the current mass flow in higher flow ranges. The Precision Mode is fully bi-directional with continuous output at and around zero. The Extended Mode is uni-directional (positive flow direction only), and sensor output is restricted to the flow range between 2000 nl/min to 22000 nl/min. The calibration for each mode is stored on a separate calibration field (CF):

- Calibration field 0: Precision Mode (default)
- Calibration field 1: Extended Mode

For switching between the two modes of operation the internal calibration field has to be selected accordingly. This can be done either by using the Sensirion USB/RS485 Viewer Software or by specific digital commands (see additional documentation, available on request for either I²C or RS485 communication).

2 Specifications Charts

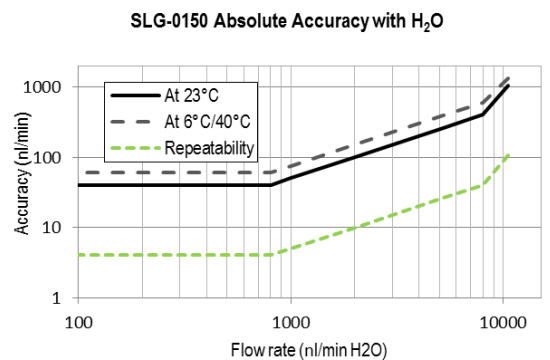
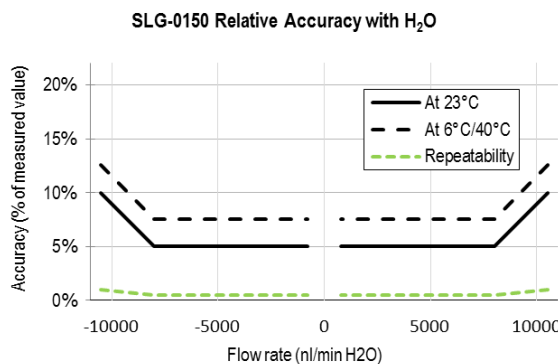
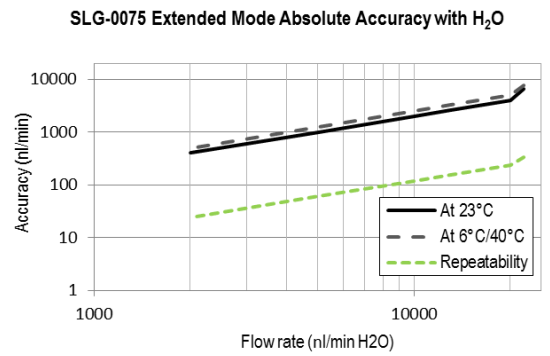
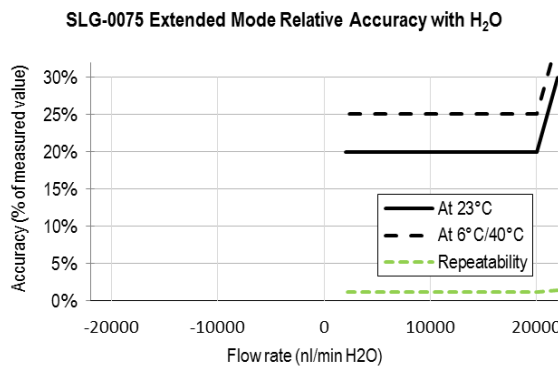
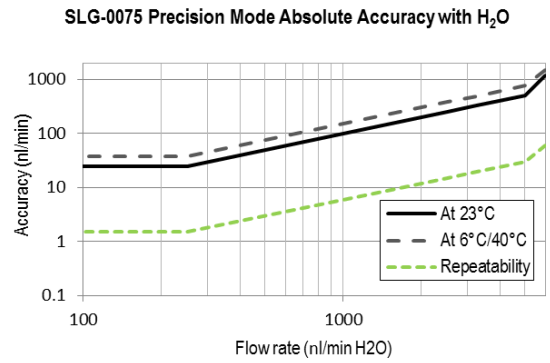
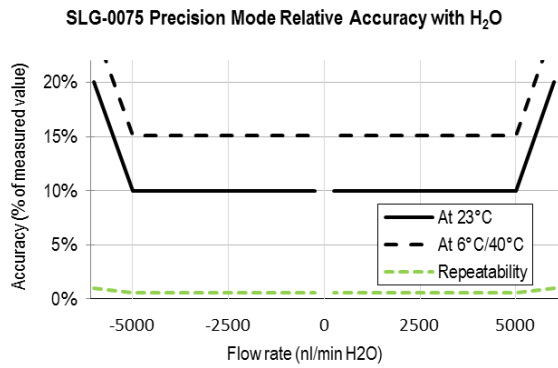
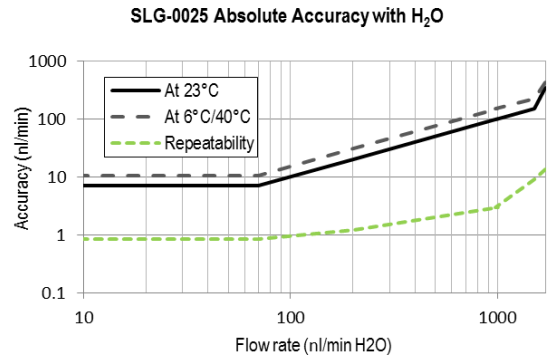
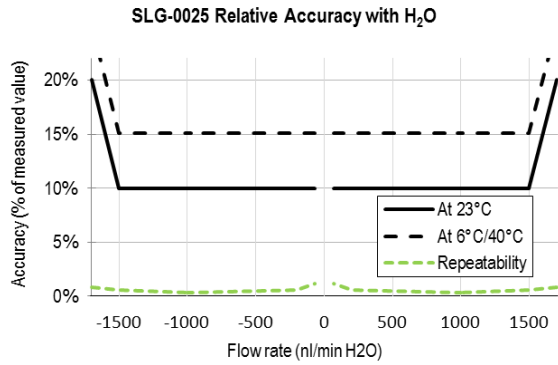

Figure 1: Flow meter accuracy and repeatability across the flow range. Relative error in % of measured value (left column) and absolute error in nl/min (right column) for H₂O

3 Communication with the Sensor

The SLG flow meter shows bidirectional, linear transfer characteristics. The product comes fully calibrated for water.

Digital Sampling Time, 16 bit	74 ms
Digital Sampling Time, 9 bit	1 ms

3.1 Electrical Specifications

Table 2: DC Characteristics

Parameter	Conditions	Min.	Typ.	Max.	Units
Power Supply DC, VDD	Sensor only	4	5	6	V
	w. SCC1-RS485	4	5	6	V
	w. SCC1-Analog	12	24	36	V
Operating Current	VDD = 4-6 V		5.1		mA
	w. SCC1-RS485		20	70	mA
	w. SCC1-Analog		4.3		mA

3.2 Electrical Connector and Pinout

The flow meter is equipped with a male connector type M8, 4-pin, threaded lock according to IEC 61076-2-101 (Ed. 1)/ IEC 60947-5-2, and is compatible with Sensirion's SCC1 interface cables.

Table 3: Electrical pinout

Pin	
1	SDA (data)
2	GND
3	VDD
4	SCL (clock)

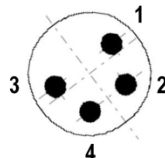

3.3 Communication via USB cable

The Sensirion USB Sensor Cable provides an easy to use USB Interface for laboratory and desktop use.

For further information please see the SCC1-USB Sensor Cable datasheet, available on www.sensirion.com/liquidflow-download.

3.4 Digital Communication via RS485-Bus

The SCC1-RS485 Sensor Cable for flow sensors allows the communication via RS485 interface for use in a demanding industrial automation environment. In addition to the standard commands available in the

I²C interface of the sensor, the incorporated microcontroller of the cable provides more complex logic such as a dispense volume totalizer, automatic dispense detection, automatic heater control and data buffer for asynchronous read-out.

For further information please see the SCC1-RS485 Sensor Cable datasheet, available on www.sensirion.com/liquidflow-download.

3.5 Analog Communication

The SCC1-ANALOG Sensor Cable allows simple and quick readout of Sensirion's liquid flow meters by converting the digital sensor reading to a 0...10.5 V analog voltage output. Additionally, a digital (high/low) output with two different modes of operation is available (Flow Switch / Volume Counter).

For further information please see the SCC1-Analog Sensor Cable datasheet, available on www.sensirion.com/liquidflow-download.

3.6 Digital Communication via I²C-Bus

Digital communication between a master and the SLI sensor runs via the standard I²C-interface. The physical interface consists of two bus lines, a data line (SDA) and a clock line (SCL) which need to be connected via pull-up resistors to the bus voltage of the system.

These lines can be used on 3.3V or 5.0V level with a clock frequency of 100 kHz. For the detailed specifications of this I²C communication, please refer to specific I²C Application Notes from Sensirion.

Table 4: I²C Output Characteristics

Parameter	Min.	Typ.	Max.	Units
I ² C Bus Clock Frequency	100			kHz
Output Voltage Low (SDA/SCL), I _{sink} = 6mA		0.1	0.5	V
Low Level Output Current (SDA/SCL)			6	mA
High Level Input Voltage (SDA/SCL)	2.0			V
Low Level Input Voltage (SDA/SCL)			1.0	V

4 Fluidic Connection

Table 5: Fluidic Specifications

Parameter	SLG-0025	SLG-0075	SLG-0150
Wetted Materials:			
• Internal sensor tube material	Fused Silica		
• Fitting material	Titanium		
• Sealing material	PEEK		
Fluid connector ports (Fittings)	10-32 coned port for Upchurch ferrules, nanoViper™ compatible		
Pressure drop (at full scale flow rate, H ₂ O, 23°C)	2 bar	100 mbar	10 mbar
Total internal volume	100 nl	350 nl	1200 nl

For more information on the fluidic connection please find: “Application Note Sensor Ports and Tubing Connections” in the Download Center on our webpage (www.sensirion.com/liquidflow-download).

5 Mechanical Specifications

Table 6: Mechanical Specifications

Parameter	SLG-0025	SLG-0075	SLG-0150
Largest dimensions	80 x 30 x 20 mm		
Total mass	150 g		
Inner diameter d	25 µm	75 µm	150 µm
Protection class	IP 53		

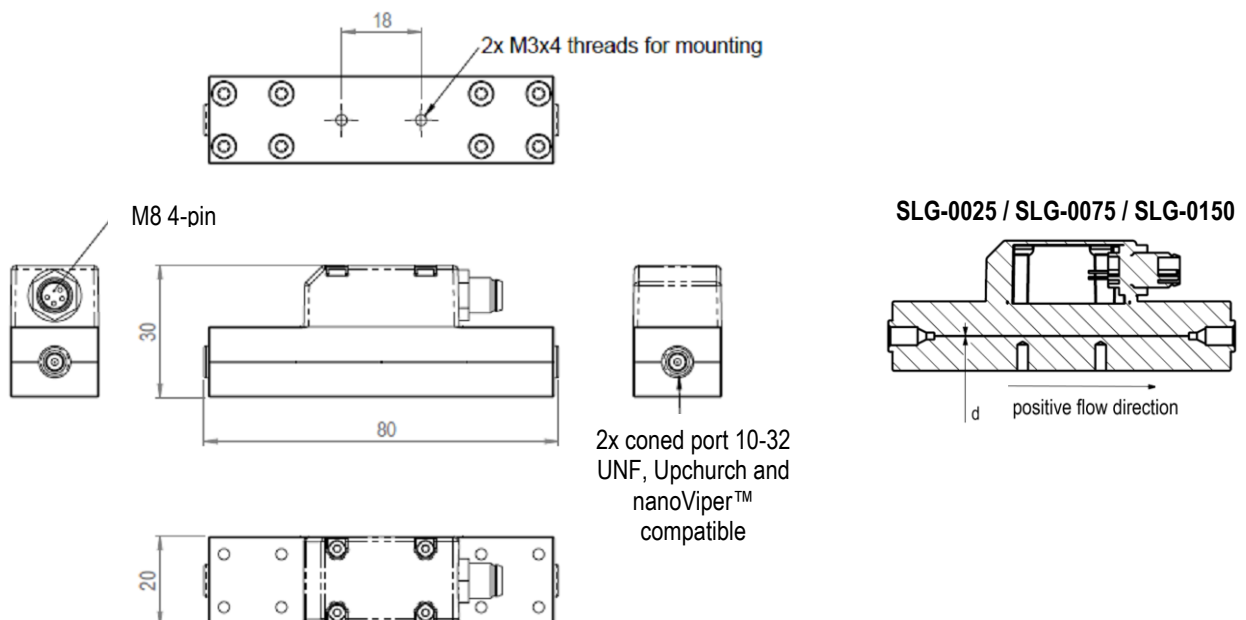

All dimensions in mm

Ordering Information

For OEM applications, the flow meter can be purchased in larger quantities without any additional parts. For optimum performance, Sensirion recommends using the SLG flow meters in combination with the SCC1 interface cables.

For laboratory use and technology evaluation, the Flow Meter Kit SLG-xxxx can be ordered.

This laboratory-package contains:

- Liquid Flow Meter SLG-0xxx
- Fitting Material for UHP fittings
- PC Software (Viewer & Data Export Tool)
- SCC1-USB Sensor Cable with USB connector for plug-and-play connection to a PC
- SCC1-Analog Sensor Cable with 0-10 V voltage output.

Table 7: Ordering information

Product	Article Number
SLG-0025 UHPLC Liquid Flow Meter	1-101316-01
SLG-0075 UHPLC Liquid Flow Meter	1-100592-02
SLG-0150 Liquid Flow Meter	1-101374-01
Flow Meter Kit SLG-0025	1-101334-01
Flow Meter Kit SLG-0075	1-100896-02
Flow Meter Kit SLG-0150	1-101389-01

Interface Cables:

SCC1-RS485 Sensor Cable Pigtail 2m	1-100804-01
SCC1-RS485 Sensor Cable Pigtail 5m	1-101122-01
SCC1-ANALOG Sensor Cable Pigtail 2m	1-101072-01
SCC1-ANALOG Sensor Cable Pigtail 10m	1-101219-01
SCC1-USB Sensor Cable 2m	1-101007-01

Important Notices

Warning, Personal Injury

Do not use this product as safety or emergency stop devices or in any other application where failure of the product could result in personal injury. Do not use this product for applications other than its intended and authorized use. Before installing, handling, using or servicing this product, please consult the data sheet and application notes. Failure to comply with these instructions could result in death or serious injury.

If the Buyer shall purchase or use SENSIRION products for any unintended or unauthorized application, Buyer shall defend, indemnify and hold harmless SENSIRION and its officers, employees, subsidiaries, affiliates and distributors against all claims, costs, damages and expenses, and reasonable attorney fees arising out of, directly or indirectly, any claim of personal injury or death associated with such unintended or unauthorized use, even if SENSIRION shall be allegedly negligent with respect to the design or the manufacture of the product.

ESD Precautions

The inherent design of this component causes it to be sensitive to electrostatic discharge (ESD). To prevent ESD-induced damage and/or degradation, take customary and statutory ESD precautions when handling this product.

See application note "ESD, Latchup and EMC" for more information.

Warranty

SENSIRION warrants solely to the original purchaser of this product for a period of 12 months (one year) from the date of delivery that this product shall be of the quality, material and workmanship defined in SENSIRION's published specifications of the product. Within such period, if proven to be defective, SENSIRION shall repair and/or replace this product, in SENSIRION's discretion, free of charge to the Buyer, provided that:

- notice in writing describing the defects shall be given to SENSIRION within fourteen (14) days after their appearance;
- such defects shall be found, to SENSIRION's reasonable satisfaction, to have arisen from SENSIRION's faulty design, material, or workmanship;
- the defective product shall be returned to SENSIRION's factory at the Buyer's expense; and
- the warranty period for any repaired or replaced product shall be limited to the unexpired portion of the original period.

This warranty does not apply to any equipment which has not been installed and used within the specifications recommended by

SENSIRION for the intended and proper use of the equipment. EXCEPT FOR THE WARRANTIES EXPRESSLY SET FORTH HEREIN, SENSIRION MAKES NO WARRANTIES, EITHER EXPRESS OR IMPLIED, WITH RESPECT TO THE PRODUCT. ANY AND ALL WARRANTIES, INCLUDING WITHOUT LIMITATION, WARRANTIES OF MERCHANTABILITY OR FITNESS FOR A PARTICULAR PURPOSE, ARE EXPRESSLY EXCLUDED AND DECLINED.

SENSIRION is only liable for defects of this product arising under the conditions of operation provided for in the data sheet and proper use of the goods. SENSIRION explicitly disclaims all warranties, express or implied, for any period during which the goods are operated or stored not in accordance with the technical specifications.

SENSIRION does not assume any liability arising out of any application or use of any product or circuit and specifically disclaims any and all liability, including without limitation consequential or incidental damages. All operating parameters, including without limitation recommended parameters, must be validated for each customer's applications by customer's technical experts. Recommended parameters can and do vary in different applications.

SENSIRION reserves the right, without further notice, (i) to change the product specifications and/or the information in this document and (ii) to improve reliability, functions and design of this product.

Copyright© 2019, by SENSIRION.
CMOSens® is a trademark of Sensirion
All rights reserved

CE, RoHS, REACH and WEEE Statement

The flow meters of the SLG series comply with requirements of the following directives and regulations:



- The device fully complies with norm EN 50081-2 (Emission Test Series), EN 50082-2 (Immunity Test Series) and ESD protection when used in combination with the SCC1-RS485 or SCC1-ANALOG Sensor Cables.
- EU Directive 1907/2006/EC concerning Registration, Evaluation, Authorization and Restriction of Chemicals (REACH)
- EU Directive 2002/96/EC on waste electrical and electronic equipment (WEEE), OJ13.02.2003; esp. its Article 6 (1) with Annex II.
- EU Directive 2002/65/EC on the restriction of certain hazardous substances in electric and electronic equipment (RoHS), OJ01.01.2011

Headquarters and Subsidiaries

Sensirion AG

Laubisruetistr. 50
CH-8712 Staefa ZH
Switzerland

phone: +41 44 306 40 00

fax: +41 44 306 40 30

info@sensirion.com

www.sensirion.com

Sensirion Taiwan Co. Ltd

phone: +886 3 5506701

info@sensirion.com

www.sensirion.com

Sensirion Inc., USA

phone: +1 312 690 5858

info-us@sensirion.com

www.sensirion.com

Sensirion Japan Co. Ltd.

phone: +81 3 3444 4940

info-jp@sensirion.com

www.sensirion.co.jp

Sensirion Korea Co. Ltd.

phone: +82 31 337 7700~3

info-kr@sensirion.com

www.sensirion.co.kr

Sensirion China Co. Ltd.

phone: +86 755 8252 1501

info-cn@sensirion.com

www.sensirion.com.cn

To find your local representative, please visit www.sensirion.com/distributors

Revision History of the SLG Datasheet

Revision	Date	Description
7	March 2019	Upgraded fitting material from stainless steel to titanium. Effective with serial numbers 1910-00000 and up.